

# M13701/M13702

## INSTALLATION INSTRUCTIONS SHEET

### START FROM HERE

- Make sure power is completely off at the fuse box.
- Have your fixture installed by a qualified licensed electrician
- Prepare everything in clear area.
- Wear gloves at all times during this installation.
- Read instructions carefully before you start assembly.
- Keep this instruction sheet for future reference.

**Technical Support:** 1-844-628-8368

### Please Note:

- All Matteo Lighting fixtures come with pre-wired module(s).
- Unless instructed to do so, please do not touch any part of the module(s) as any unnecessary contact with the module could cause permanent damage.

THIS LUMINAIRE MUST BE MOUNTED OR SUPPORTED IN A JUNCTION BOX  
*CE LUMINAIRE DOIT ÊTRE MONTÉ OU SUPPORTÉ DANS UNE BOÎTE  
DE JONCTION*

- 1 Ensure main supply is switched off.
- 2 Fit mounting board onto mounting surface with self-tapping screws (1).
- 3 Insert masonry plugs (2) into mounting surface.
- 4 Connect wires (3) according to color (White to White, Black to Black). Connect all earth plug together onto the crossbar with green screw to tight. .
- 5 Fix the ceiling plate securely onto the mounting bracket with screws (4, 5).
- 6 Fix lamp shade onto lampholder with screws (6).
- 7 Reconnect power.

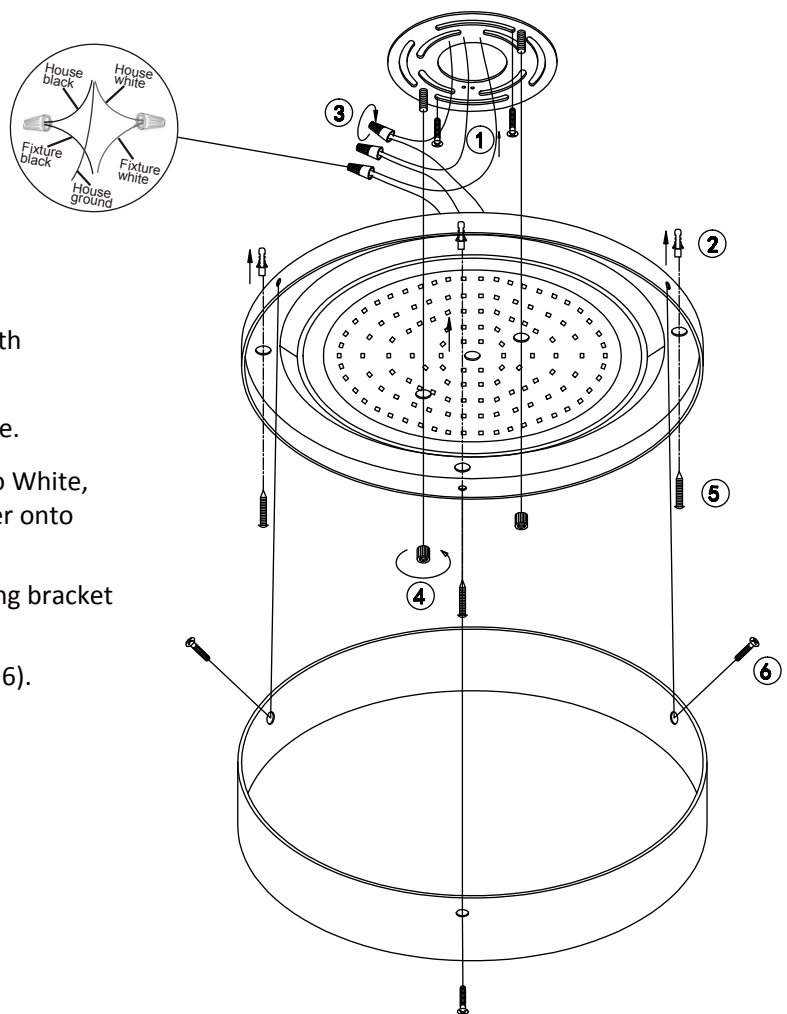

### WARNING:

This fitting must be earthed.

Disconnect power and allow fitting to cool down before cleaning or changing the lamp.