

INSTALLATION INSTRUCTIONS

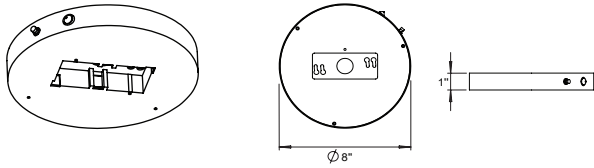

Round LED Slim Surface Mount with Emergency Battery Backup



SAFETY PRECAUTIONS

For safety, read and understand instructions completely before starting installation. Electricity should be turned off at the fuse or the circuit breaker box before installing the fixture. All electrical connections must be in accordance with N. E. C. or your local code.

PACKAGE CONTENTS

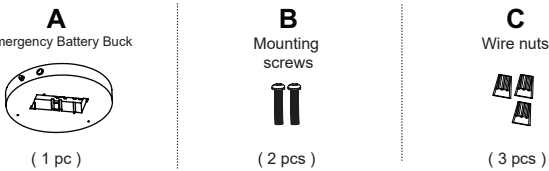

ASSEMBLY INSTRUCTIONS

1. Preparing for installation
Disconnect electrical power before installing or servicing any part of this fixture.
2. This product SHALL be surface mounted with junction box or non-combustible surface above 4 feet (1.2 meter) high. User should prepare necessary accessories and spare parts (not provided) including junction box and screws.

TOOLS REQUIRED

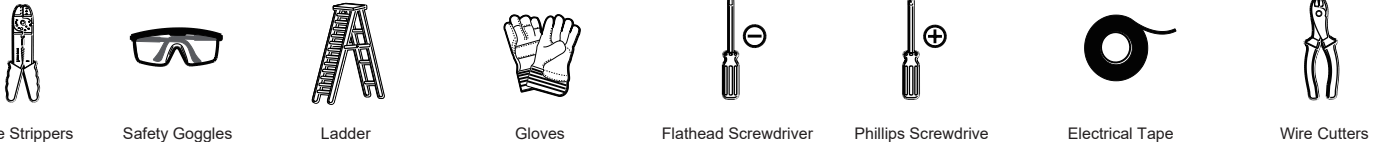

INSTALLATION (CONSULT A QUALIFIED ELECTRICIAN BEFORE INSTALLING)

Step 1: Turn off /Disconnect power at Circuit breaker. Typical junction box wiring has only white & black switched wires controlled by wall switch for on/off or dimming. Ensure the junction box has an additional set of UNSWITCHED WIRES (continuous) main power wires available if necessary, add these wires as shown. (Fig A, E and F)

Step 2: Screw the Emergency Backup unit up into the junction box using the 2x8/32 screws provided. Install the mounting plate into the Emergency Backup. Then using the wire unit provided, connect the three (3) cables available for connection into the junction box as shown in Fig B.

- a. Connect the "Switched Line" to the black switched power cable coming from the junction box.
- b. Connect the "Continuous Main Power" from the battery backup box to the continuous main black wire from the junction box.
- c. Connect the "Neutral" white wire from the battery backup together with the other two neutral wires coming.

Step 3: Make electrical connections from the Blink LED lighting fixture with the battery backup (Fig C).

- a. Use the orange connector already supplied and affixed to the unit.
- b. Be sure to connect the ground wire coming from the lighting fixture.

Step 4: Pop n lock into place (Fig D).

- a. Feed all wires up into the battery backup box and raise the lighting fixture up to the ceiling.
- b. Align the edge of the fixture with the ball bearings on the mounting bracket and Pop N Lock into place.

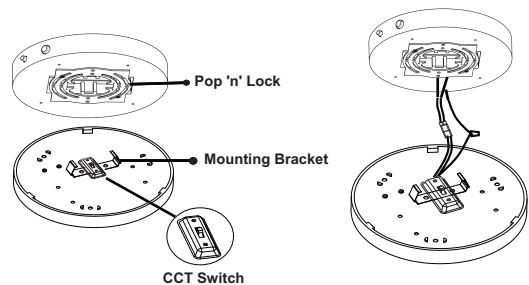
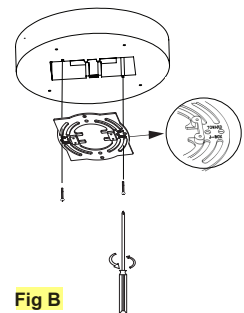
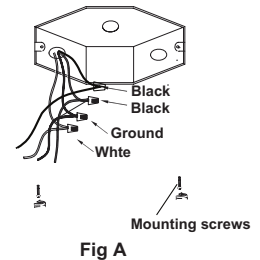

CAUTION: RISK OF ELECTRIC SHOCK
DISCONNECT POWER BEFORE CONNECTING THE FIXTURE.
FAIL TO DO SO MAY PERMANENTLY DAMAGE THE LEDS.

WARNING:
DO NOT REMOVE OR ATTEMPT TO REMOVE LEDS.

INSTALLATION INSTRUCTIONS



Round LED Slim Surface Mount with Emergency Battery Backup

SAFETY PRECAUTIONS



For safety, read and understand instructions completely before starting installation. Electricity should be turned off at the fuse or the circuit breaker box before installing the fixture. All electrical connections must be in accordance with N. E. C. or your local code.

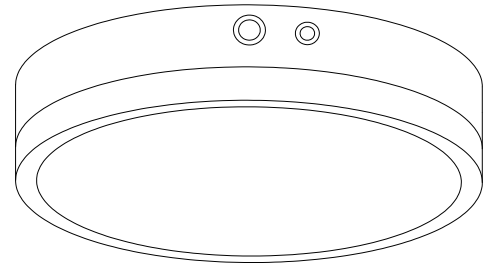

CONSULT A QUALIFIED ELECTRICIAN BEFORE INSTALLING

TEST BUTTON AND LED INDICATOR TEST BUTTON FUNCTIONS

1. WHILE MAIN POWER IS ON:

A quick press of the test button, (<3 seconds), simulates the "main power outage" or "emergency mode". The light fixture will come on in this case (It will be running on battery power). Pressing the test button for 3-6 seconds puts the unit into the monthly self-check routine (approx. 3 minutes run time). Press test button again anytime to stop the routine. As the system runs its check on the battery power and circuit connections, the LED indicator will flash green @ 1 cycle/second. Pressing test button for >6 seconds puts the unit into the annual self-check routine. (up to 90 minute run time)

NOTE: THIS SYSTEM WILL COMPLETELY DISCHARGE THE BATTERY DURING THIS ROUTINE.

Press test button again anytime to stop the routine. As the system runs its more detailed annual check on the battery power and circuit connections, the LED indicator will quickly flash green @ 3 cycle/second.

2. WHILE EMERGENCY STATUS (main power outage):

Pressing test button for <6 seconds shuts off the unit, press again to turn it back on. Pressing test button for <6 seconds completely shuts off emergency output. In this state, the system will not function unless the main power is restarted.

LED INDICATOR COLORS/FUNCTIONS

RED: Battery is charging

Green: Battery is fully charged.

Yellow: Check system, possible battery replacement needed or system maintenance required.

GREEN FLASHING: Monthly or annual checking mode is running.

OFF: Indicates a power outage, when the Battery Backup unit is in emergency Mode, the LED indicator will be OFF.

MINIMUM CHARGE TIME: 24 hours.

FOR CONTINUOUS POWER APPLICATIONS

If the battery backup is used for:

1. A system with 24/7 lighting OR
2. As dedicated Emergency Lighting only, (light off in normal condition). Only continuous UNSWITCHED power is needed at the junction box (No need for switched wires).

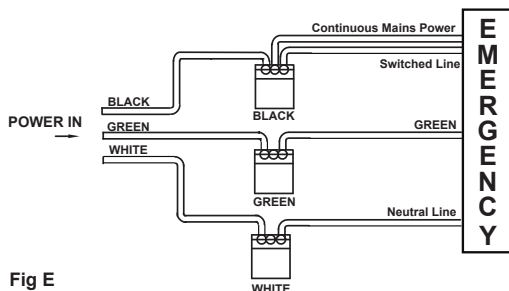

Fig E

For Option 1, above as 24/7 lighting:

1. Connect the two black wires (labeled as "Continuous Main Power" and "Switched Line") from the battery backup to the black main wire in the junction box and connect the white ("Neutral") to white from the box wires.
2. Screw the Emergency Backup unit up into junction box using the 2x8/32 screws provided then, go to Step 4 (Show in page 1)

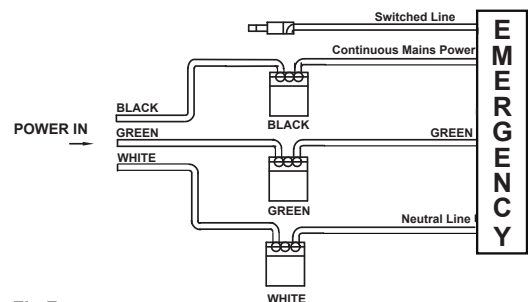

Fig F

For Option 2, above as Emergency Light only:

1. Connect the black wire (labeled as "Continuous Main Power") from the battery backup to the black main wire in the junction box and Connect white ("Neutral") to white from the battery backup fixture to junction box.
2. Screw wire nut over the "Switched Line" and leave unconnected. Then screw the Emergency Backup unit up into the junction box using the 2x 8/32 screws provided, then go to Step 4 (shown above)